

OPERATION MANUAL
of step motor controllers type:

DMD560-SV, DMD860-SV, DMD88100-SV

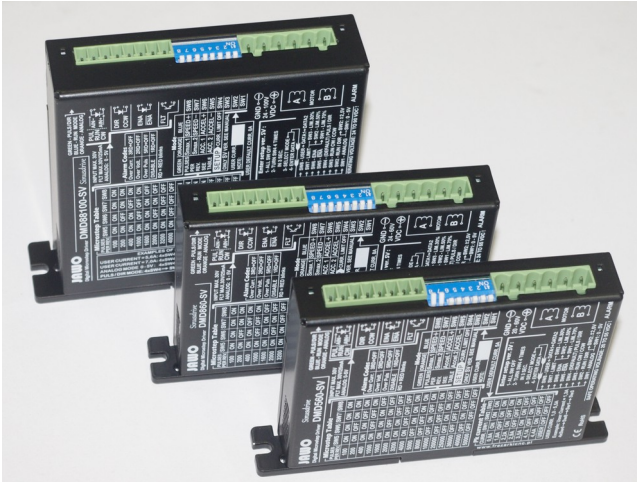

**High-efficiency controllers with built-in motion generator
and analogue input to control rotation speed.**

DMD88100-SV for motor $> 5\text{Nm}$
DMD860-SV for motor $\leq 6\text{Nm}$
DMD560 SV for motor $\leq 5\text{Nm}$

Designations used in this manual:



Means potential danger and risk of body injury



Means warnings, failure to adhere may lead to improper operation or damage



Means useful information or advice

**BEFORE LAUNCHING THE DEVICE FOR FIRST TIME,
PLEASE READ THIS MANUAL CAREFULLY.**

JAWO P.P.H.U.
93-311 Łódź, POLAND
ul. Rzgowska 180 paw. 20/21
tel. 42 6458579 , 601255408
www.frezarkinc.pl
jawopphu@go2.pl

ver. 1_04 2018

General characteristics:

DMD...SV series controllers are used to control step 2- and 4-phase engines. The advanced control system generates bipolar current in the engine winding. A precise controller controls the engine's operation fluently and reducing resonances to minimum. The operation with even the smallest divisions has no unfavorable resonance effects which are typical for the step motors. The novelty control algorithms at every moment of operation adapt to the current motor's load and revolution allowing to achieve high precision and even revolutions. This results in a higher torque and higher useful revolution. DMD...SV series controllers are manufactured in 3 types differing in the maximum output current and the maximum supply voltage. All controllers are fitted with the intelligent protection systems and soft-start systems. A soft start prevents mechanical impact when activating a controller and impacts the durability of precise mechanical elements co-operating with the motor. This refers to especially the motors with a higher power in which a strong "kick" into mechanics is observed while starting. The controllers are fitted with easy step division and the values are shown in the amount of impulses per 1 revolution. When choosing the division table, the most useful division values are used that can be found in most applications. Some binary divisions are not used purposefully in favor of direct decimal divisions and rotary axis of 360 degrees. In addition to the standard control, PULSE and DIRECTION (PUL/DIR) controllers marked as "SV" have their own functional blocks allowing for motor operation within a wide range of revolution with no need to supply a series of control impulses. The step motor can be treated in this case as a normal DC motor with advantages of a high torque from the lowest speeds. Control in this case is limited to the supply of RUN input for the start and DIR for changing the revolution direction. Setting of revolution and acceleration/braking time is done with DIP-switches. Settings are saved in the non-volatile memory. For autonomous control we have two options depending on the needs: RUN/DIR or the start and change direction, and CW/CCW that is start to the left and start to the right. The motor's reaction to signals is shown in the control programming description. The user can also use the analogue input. By leading the constant voltage to the input we can easily control the revolution speed. In addition to the output current table, an advantage of the controllers is that the USER current can be set with a resolution of 0.1 A. It provides precise fit to the controlled motor. Additionally, the user can choose from 3 inactivity currents. All the setpoints and settings are made directly with DIP-switches. Controller inputs are separated with photocouplers.

TECHNICAL DATA:

Supply voltage:

DMD560-SV 20 ± 60V

DMD860-SV 24 ± 60V

DMD88100-SV 24 ± 100V

Step-configured Output current:

for DMD560-SV

1,1A 1,6A 2,2A 2,9A 3,5A 4,1A 4,4A USER DEFAULT – 5A USER value set to 1,0 – 5,5A every 0,1A

for DMD860-SV and DMD88100-SV

2,9A 3,5A 4,2A 5,4A 6,1A 7,2A 7,8A USER DEFAULT – 8,2A USER value set to 1,0 – 8,8A every 0,1A

The inactivity current is set after 0.5 seconds to 30%, 50%, 70%, without limit.

The micro-step division in impulses per 1 revolution:

100,200,400,1000,1600,2000,3200,4000,5000,8000,10000,20000,25000,36000,40000,50000

Current amplifier keying frequency: 20 KHz

Sinusoid shaping – automatically depending on revolutions, lower range of PID regulator, upper range FUZZY LOGIC

Positional control – PUL/DIR signal per quadrature signal

PUL signal frequency – max. 300 KHz (also for quadrature signal)

DIR signal ahead time before PUL – 10 ns. (virtually irrelevant with DIR priority)

Impulse duration PUL min. 100 ns.

Alarms signaled with flashes of a red LED:

1 flash – break: slowed drive (DISABLE) – requires no reset

2 flashes – break: surge, temporary surge – signal. Surge above 5 sec. – restart required

3 flashes – break, surge, restart required

5 flashes – break: excessive PUL frequency, restart required

Input logics – TTL 0 -30 V inputs are resistant to voltages of max. 35 V

Input signal current – ca. 8 mA built-in current sources operate within the range up to 40 V

Insulation resistance – 500 MΩ

Revolution range at RUN operation from ca. 0.2 – 50 rev/sec.

Ramp setting – 10 degrees of inclination, acceleration/braking curve S – curve.

FLT output – open collector max. 30 V and 25 mA active with overload alarms and surge alarms

Protections: short-circuit, voltage, phase-phase short-circuit, phase – mass short-circuit.

Signaling a temporary exceeded supply voltage (caused by excessive SEM return)

Controller inputs and outputs are provided on the detachable power strips

For fastening controllers to TH35 rail, fasteners are provided.

Operation characteristics:

Cooling: passive or forced circulation

Operation temperature: max. 50°C

Environment temperature: 0°C - 40°C

Humidity: 40% - 90% RH without condensation

Allowable vibration 10 – 55 Hz 0.1 mm/s

Dimensions without plugs (L x W x H from fastening base):

DMD560-SV 120x75x20 mm.

DMD860-SV 120x75x20 mm.

DMD88100-SV 120x95x28 mm

Safety guidelines:



CNC machines may pose a higher risk than the manual ones. Any adjustments and operations with mechanical machine parts during the activated motor controllers are not allowed. During setting and test runs of the machine, the motor may unexpectedly move due to the interruptions from other sub-assemblies. This may pose a risk to the life and health. A step motor is an electric machine. The general rules of operation of electric machines are to be observed. Before starting the controller, make sure that the movable machine parts do not collide with other machine parts or will not cause any injury to persons.

Description of Controller signal connection:

All signal inputs and outputs are to be used for direct operation with voltages 0-30 V.

PUL+, PUL- impulse signal of TTL level, one impulse corresponds to motor shaft displacement by one step based on the division table. The controller's reaction is to the rising edge.

DIR+, DIR- impulse signal of TTL level, change of motor's rotation direction, reaction to the signal level.

ENA+, ENA- signal in TTL, causes slowing down of the motor, which is signaled by alarm diode impulses.

The reaction occurs on the signal level, polarization can be reversed by program, see programming manual.

When setting RUN operation (independent operation), RUN, DIR or CW, CCW inputs are active, therefore:

For RUN/DIR option:

RUN+, RUN- TTL signal, reaction to level, causes start of motor revolution according to the set speed and acceleration ramp.

DIR+, DIR- TTL signal, reaction to level, determines motor rotation direction, change of state during RUN signal causes immediate change of direction considering the programmed ramp.

For CW/CCW options:

CW+, CW- TTL signal, reaction to level, causes start of rotation to the right.

CCW+, CCW- TTL signal, reaction to level, causes start of rotation to the left.

For ANALOG option (independent operation), AN+, AN- and DIR inputs are active.

AN+ and AN- voltage inputs. Voltage of 0-5 V causes revolution adjustment within 0 – 50 rev/sec.

DIR+, DIR- TTL signal, reaction to level, determines motor rotation direction, change of direction only with voltage AN+ AN- of 0 V.

NOTE!



Motor rotation direction depends on the sequence of connection of motor phases. It can be easily changed by reverse connection of one of the motor windings.

Description of Controller output connection

A – motor phase 1 winding supply output

B - motor phase 2 winding supply output

VDC + DC supply, positive pole, value depends on the type of controller – see characteristics.

GND – DC supply mass

NOTE!





If high revolution and dynamics of the motor is required, use the supply voltage close to the upper limit of the supply voltage for a given type of controller. But it is related to the higher motor heating. In low-speed applications, a good principle is to use 60% of maximum voltage.

Power supply of controllers:

It is recommended to use non-stabilized transformer power unit for supplying controllers. It is allowed to use impulse power units under the appropriate current capacity and tolerance of impulse loads. An improper impulse power unit may cause emergency disconnection of the controller and interruptions in power supply. This may result in interruptions in the machine (mechanism) operation that are difficult to identify. The transformer power units tolerate temporary surges very well so they are the best solution to supply the controllers.

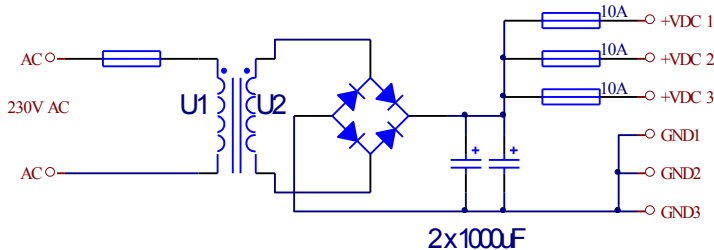
The block diagram of the simplest transformer power unit for 3 controllers is shown below:





 Pay particular attention to the supply method of individual controllers as each controller must be connected with the wires to the power unit. It is not allowed to connect controller supply in parallel where the power cables connect the controllers with each other. For clarity – all the power cables of controllers meet on the power unit located as close to the filter condensers as possible. The controller supply voltage will be: $U_2 \times 1.4$. If we need a voltage of 50 V, the alternate voltage of the secondary transformer side should be $50 / 1.4 = 35.7$ V. Regarding the filter condensers, parallel-connected condensers should be used to reduce the internal impedance. We connect 2 – 4 condensers together, total capacity 2,000 – 4,000 µF. An important thing is to choose the current capacity of a transformer. For a controller supplied with a voltage of 50 V which controls the motor with a rated voltage of 5 A, the consumption of current from the power unit at standstill is ca. 0.5 A and 1.5 A for medium revolutions. Virtually, for a machine like the 3-axis milling machine (ignoring the calculations given in various sources) we can assume the transformer rated current of 4A with the secondary side voltage of 37V. Similarly for the controllers with voltage supply of 75 -85 V for 3 motors with 7.8 A, the transformer should supply the rated current of 5 A. These are the practical values we have used as a manufacturer of CNC millers for several years. The lower current value is due to the fact that the CNC millers very rarely operate together with a maximum load. In general solutions, we can assume the transformer current of 40% of the current in a motor supplied with a controller if the controller supply voltage is higher than the half of the controller rated voltage.

NOTE!: Reverse connection of controller supply may result in its damage.

Connection of controller with motor:

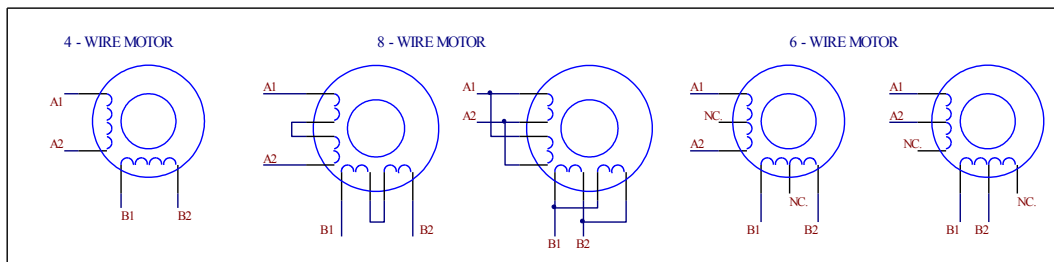
Controllers may supply the step hybrid motors with 2, 4 or 8 wires. Combinations of winding connections for different motors are shown below.



 When choosing a motor, pay attention to its inductance and if the application requires high revolution rate and dynamics of movement, use motors with lower inductance. It is not that important for low-speed applications.

 For connecting the controller with a motor, use shielded cables with a copper conductor section of min. 0.75 mm², for the motor current 8A min. 1 mm². If necessary to use cables with a length of more than 4 mb the section should be increased appropriately. The shield of motor cables should be connected with the mass only on one side that is on the controller's side. It is best to provide it with a metal clamping ring by fastening the shield braid to the fixing plate of the control cabinet. When routing cables, pay attention to maintain a distance of min. 10 cm of the motor cables from the signal cables.

Pay particular attention to pressing power pins into the sockets as due to the high currents, the connection

must be provided properly with pins fully pushed. It is not allowed to disconnect and connect pins with the controller powered on. Handling pins under voltage results in burning of pins and damage to the controller.

Connection of control signals:

For the controller operation under PULS/DIR, connect the input signals PUL and DIR. For this purpose, the signal cables PUL+ and PUL- must be fixed together as well as the signal cables DIR+ and DIR-. This twisted pair prevents penetration of external interruptions into the input signals. For the control of inputs from the symmetrical line transmitter, the same twisted pair should be used as well. All controller inputs have the active current sources. Signals of max. voltage 30 V can be supplied safely. This relieves an engineer from choosing additional resistors limiting the input current. They are not needed for our controllers. The controllers are fitted with alarm inputs used to transmit the alarm signal to the controller. The output is galvanically insulated from internal voltages of the controller. The output on the outside of the controller is marked as FLT+ and FLT- is the open collector with the safety current source. The example method of connecting alarm inputs with the primary circuit is shown in the diagram.

Examples of connection of controller alarm outputs:

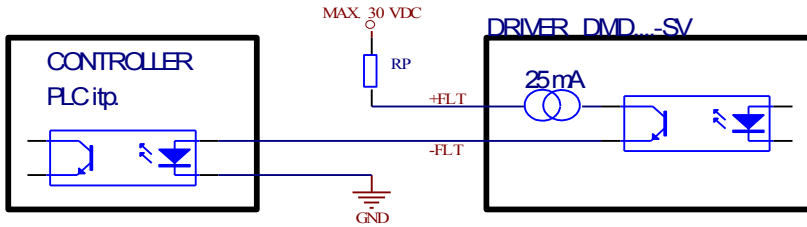

RP resistor should fit the characteristics of photocouplers used in co-operating devices, for VDC = 5 V RP is ca. 270 Ω . Maintaining the safety limit, a current of 20mA should not be exceeded.

Below is an example of the direct control with the relay coil:

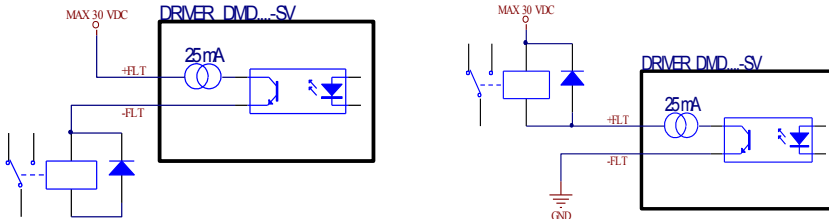

For direct control, relays with the trigger current ca. 20 – 25 mA (limited current in controller) are recommended. The relay coil should have a resistance of 1.2 – 2.4 K Ω for voltage Vcc = 24V. For Vcc = 12 V, the coil resistance should be within 0.6 – 1.2 K Ω . It is recommended to use relays with a built-in quench diode or provide a diode in parallel to the relay coil as in the diagram. The alarm output is activated with the surge and overload alarms and can be used to stop the machine.

TYPES OF CONTROLLER OPERATION

Type of operation is indicated with a LED color.

Under PULS/DIR, the green LED is on. This is the mode used for CNC millers and lathe.

PUL input can be normally controlled with a series of impulses and DIR input is used to change the direction. The quadrature signal can also be controlled as the controller is prepared for this and requires no special treatment.

Under RUN/DIR and CR/CCW, a blue LED is on. This mode enables motor control even with the switches. Giving a high level for the RUN input starts the motor with pre-set revolution rate. This mode largely simplifies designing various types of feeders, conveyors, etc. Additionally, the option to set the motor current allows to use a step motor as an overload coupling with a proper power, for example, in a bottle capping machine. By using the direct control of the quadrature signal, we can add the incremental encoder to the PUL and Dir inputs of A and B signals. Thus, we have a simple and accurate keypad or the torque amplifier for manual control.

The controllers are fitted with the analogue voltage meter module.

Under ANALOGUE mode, the orange LED is on. In this mode, the voltage supplied to inputs AN+ and AN- linearly controls the motor revolution within 0 to 50 rev/sec. ANALOGUE operation enables two adjustment methods:

- Linear adjustment of revolution from 0 to max. 50 rev/sec. in one direction (change of direction with DIR input)
- Reverse adjustment of voltage -2.5 V to +2.5 V. Change of revolution rate after passage through 0 V.

For analogue adjustment near 0 V a small (-0.1 V to +0.1 V) insensitivity zone is set to prevent controller's response to low interrupting voltages while revolution is stopped – 0 V.

Further diagrams show the examples of motor response depending on the control method:

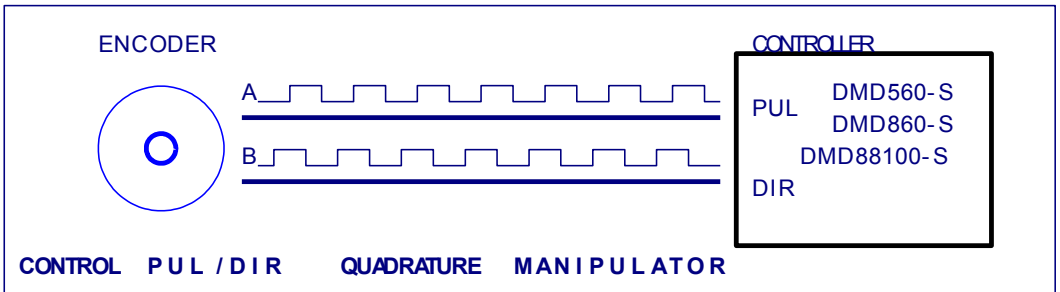
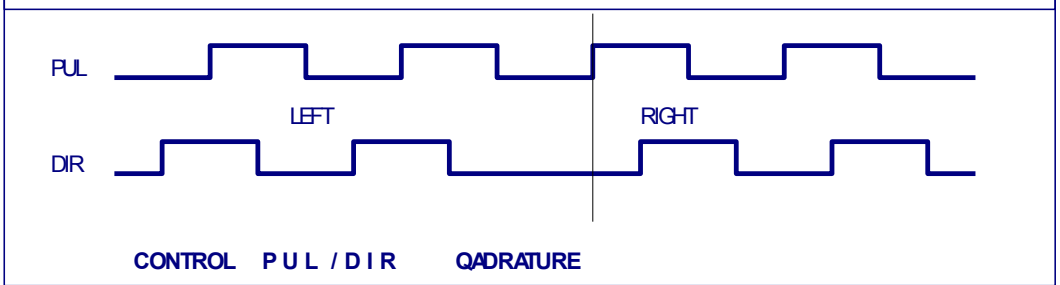
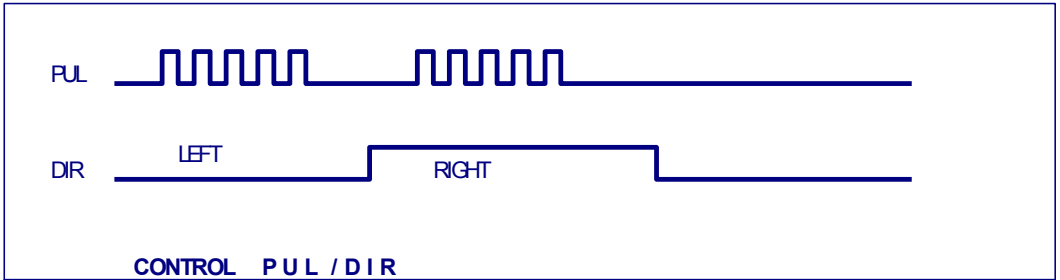

Graphs show the response of controller in the function of analogue input voltage.

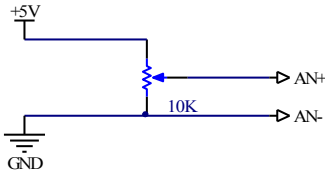
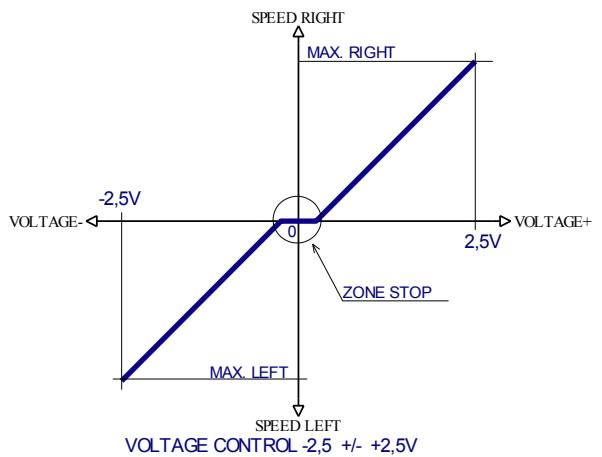
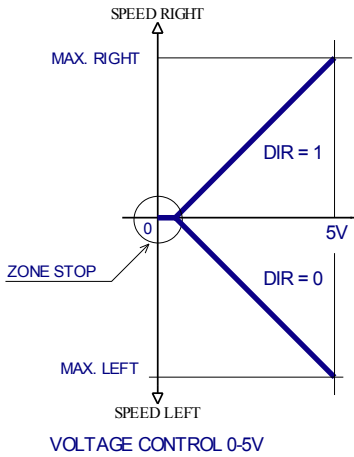

ANALOG CONTROL

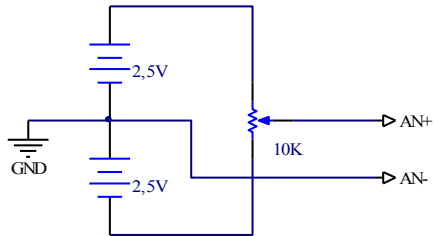

REVERS CONTROL -2,5V - +2,5V

Tables below show the settings of maximum revolutions and ramp times for operation under ANALOGUE 5V mode. ANALOG +/- 2.5 V does not use the ramps.

| SW-8 | SW-7 | Rev. max. |
|------|------|-------------------|
| OFF | OFF | ok. 1/2 rev./sec. |
| OFF | ON | 6 rev./sec. |
| ON | OFF | 25 rev./sec. |
| ON | ON | 50 rev./sec. |

| SW-6 | SW-5 | Time Ramp |
|------|------|-------------|
| OFF | OFF | ok. 0,1sec. |
| OFF | ON | ok. 1 sec. |
| ON | OFF | ok. 2 sec. |
| ON | ON | ok. 4 sec. |



NOTE! The User must ensure the maximum limit of analogue voltages. Exceeding a voltage of 5 V or under the reverse operation mode -2.5 V or 2.5 V may result in the sudden motor stoppage or interruption.

PROGRAMMING SETTINGS OF DMD... SV SERIES CONTROLLERS

Indication of controller status with LEDs

Red ALARM signal light:

Single impulse, break – disabled controller, motor slows down

2 impulses, break – controller emergency disabled, active voltage protection – reset by disabling

3 impulses, break - controller emergency disabled, active overcurrent protection – reset by disabling

5 impulses, break - controller emergency disabled, active max. PLUS protection – reset by disabling

Continuous fast pulsing – awaits setting of all DIPSW into OFF, occurs during programming.

Single impulse indicates saving to the memory.

Green PULS/DIR signal light:

Continuous light – normal operation under PULS/DIR mode for CNC machines

even pulsing – awaits for MODE selection

single short flashes – awaits entry of 1st value

double short flashes – awaits entry of 2nd value

Blue RUN signal light:

Continuous light – normal operation under RUN/DIR and RUN CW/CCW modes

Orange ANALOGUE signal light:

Continuous light – normal operation under voltage adjustment

SETUP MENU AND PROGRAMMING OF SETTINGS:

Before programming, it is recommended to disable the impulse signal led to PULS input. Entry into the SETUP is after 4-time light pressing of DIPSW-4. This operation should be performed evenly during max. 3 sec. The sequence should be completed by putting DIPSW-4 into OFF (top). Entry into SETUP is indicated by even flashing of the green light. If the red ALARM light is flashing, it means that DIPSW switches are not OFF so disable them all and the green light will flash awaiting the selection of value to be set.

The setting time starts now. If no operation is performed, the controller will move to normal operation after 30 seconds while maintaining the last saved settings.

Then, we can choose the value we want to change:

SW1 – choose ANALOG – after enabling, indication (red LED) of the need to disable DIPSW;

then the single short flashes of the green diode mean awaiting a value input:

SW1 – analogue input 0 – 5 V (change of direction by status on DIR input)

SW2 – analogue input -2.5 V to +2.5 V change of rotation direction depending on polarization.

after choosing a given value, settings are saved and the system quits programming.

SW2 – choose RUN/DIR saves and exits programming

SW3 – CW/CCW selection saves and exits programming

SW4 – loads default settings (PULS/DIR, USER DEFAULT current, 50% limit, ENA negated), saves and quits programming.

SW 5 – ENA selection (signal slows down the drive) saves and quits programming

SW6 – ENA selection (the drive requires a signal to be provided) saves and quits programming

SW7 – inactivity current selection, indication (red LED) of the need to disable DIPSW,

single short flashes of green diode mean awaiting the value to be provided:

SW1 – inactivity current 70%

SW1 – inactivity current 50%

SW1 – inactivity current 30% saves and quits programming after selection.

SW8 – enables setting the rated current value of motor to USER. After it is enabled, the need to disable SW8 is indicated and short single flashes of the green diode indicate awaiting 1. Value to be entered – the current in amperes (from 1 to 8) and after choosing the appropriate value we return to DIPSW OFF (need to return will be indicated with a red LED), then the short double flashes of the green diode will indicate awaiting 2. value to be entered – current in 0.1 A (from 0.1 to 0.8). If the 2. value is not entered within 14 seconds, the decimal value will be set to 0. If there is an attempt to set the current value that exceeds the rated current of a controller, the maximum value for this type of controller will be programmed. Selection of value saves the settings and the system exits programming.

During operation under modes RUN/DIR and CW/CCW, SW7 and SW8 are used to set the motor rotation speed, impulse pressing causes: SW8 – increase, SW7 – reduction of motor speed. Similarly, SW5 and SW6 are used to change the ramp inclination for motor acceleration/braking. These values are entered into the controller memory 5 seconds after the last change.

During operation under ANALOGUE, SW8 and SW7 set the maximum speed limit. 4 combinations are possible, 50, 25, 6 and ½ revolutions per second, respectively. Under this mode, SW5 and SW6 are used to choose the acceleration ramp and 4 acceleration/braking times are available: 0.1, 1, 2 and 4 seconds. Under ANALOGUE mode, +/- 2.5 V of the ramp for acceleration/braking are not available. This mode can be used for servo control.

Example of setting USER current to 5.2 A:

1. Press 4 x SW4 (evenly up to 3 sec.), entry into setup menu will be indicated by flashing green LED (or red if not all DIPSW are released – release)
2. Enable SW8 (MODE – USER current setting) so that the red LED will flash.
3. Disable SW8 (green LED with single short flashes, awaiting 1. value)
4. Disable SW5 – selection of units – 5 (Red LED will start to flash)
5. Disable SW5 (green LED with double flashes, awaiting 2. value)
6. Enable SW2 selection of decimals -0.2 is saved to the memory and USER current is set to 5.2 A.

Motor response when controlling RUN/DIR and CW/CCW:

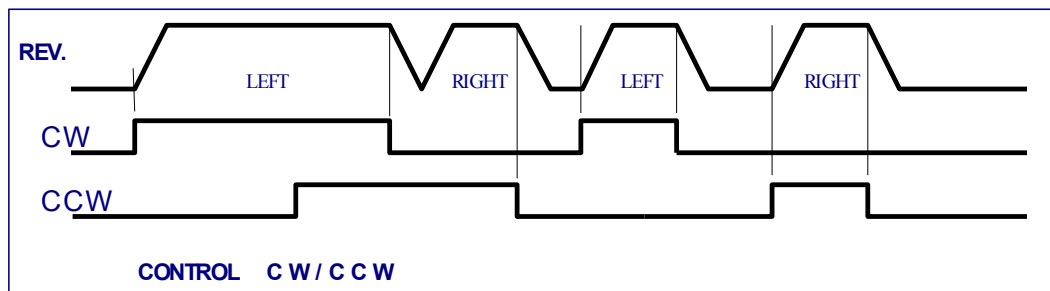
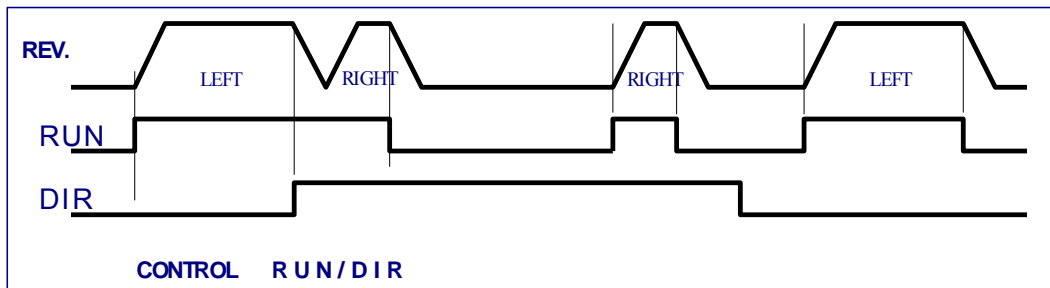

Installation of controllers:

Controllers are sold as components for a drive system. The user is responsible for proper installation according to the rules of installation of electrical devices as well as for ensuring compliance with standards of emission, interruptions and electromagnetic compatibility. The controller should be fastened vertically so that the air can freely flow around it. In case of installation of controllers in a control cabinet, it is necessary to provide efficient exchange of air through the fan. The minimum spacing of controllers is given in dimensional drawings.

Cooling of controllers:

 For operation of controllers with the output current of over 8A, the forced cooling should be used. For 4 controllers, a single fan of 80 -100 mm will be enough. Virtually, you can use 12 V fan supplied with 8 – 10 V (maximum capacity is not necessary). The safe operation of controllers will be ensured already with the light air circulation.

The supply includes:

- 1- Step motor controller of proper type
- 2- Detachable supply pin / motor
- 3- Detachable pin of control inputs
- 4- Short programming manual
- 5- Board packaging
- 6- Optional – rail fastener TH35

This manual can be downloaded from www.frezarkicnc.pl

**Dimensions of DMD560-SV / DMD860-SV
(without pin connectors and rail fastener)**

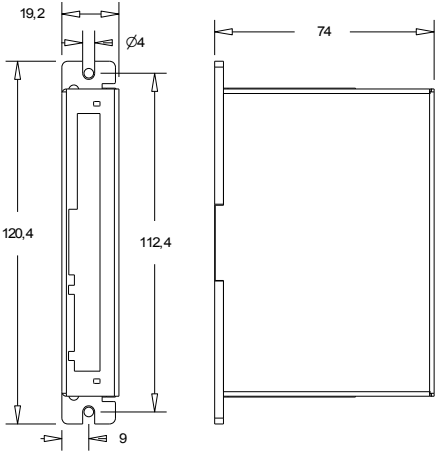

**Minimum spacing of controllers
DMD560-SV / DMD860-SV**

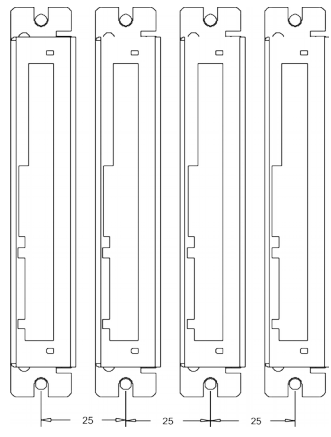

**Dimensions of DMD88100-SV
(without pin connectors and rail fastener)**

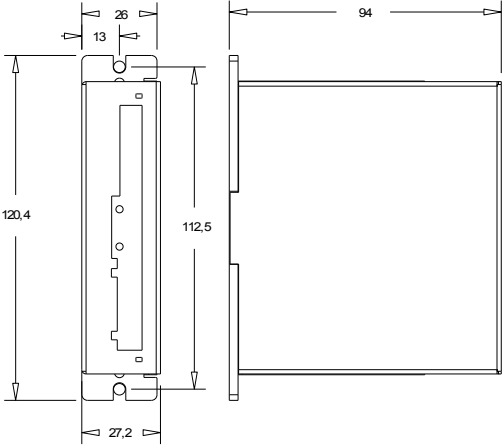

**Minimum spacing of controllers
DMD88100-SV**

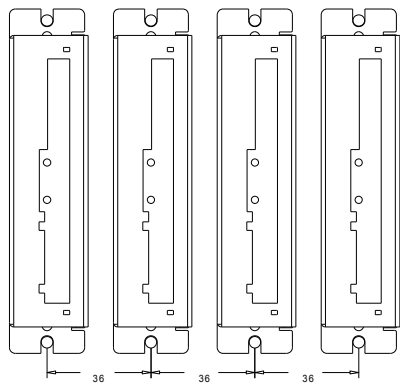

NOTE: controller casings have openings with M3 thread used to fasten the rail fastening. Pay attention not to place the fastening screws inside the casing for more than 8 mm.

USER NOTES:

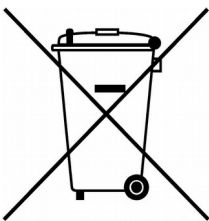

WEEE LABELLING

The used electric and electronic equipment may not be disposed with normal household waste. According to the WEEE Directive of the EU, the separate disposal methods should be employed for the used electric and electronic equipment.

In Poland, according to the rules of the Act on used electric and electronic equipment, it is not allowed to place the used equipment designated with a crossed bin symbol with other waste. The User who wants to dispose the product must leave it at the used equipment collection point. The collection points are provided by, inter alia, retail and wholesale sellers of this device and by the district organizational units engaged with waste collection. The proper fulfilment of these requirements is important especially if the used equipment has any hazardous components that affect the environment and human health.
